

INSTRUCTION MANUAL

---

**DEWALT**®

---

**D25712-XE**

48 mm (1-7/8") SDS MAX® COMBINATION HAMMER

### Definitions: Safety Guidelines

The definitions below describe the level of severity for each signal word. Please read the manual and pay attention to these symbols.

**⚠DANGER:** Indicates an imminently hazardous situation which, if not avoided, **will** result in **death or serious injury**.

**⚠WARNING:** Indicates a potentially hazardous situation which, if not avoided, **could** result in **death or serious injury**.

**⚠CAUTION:** Indicates a potentially hazardous situation which, if not avoided, **may** result in **minor or moderate injury**.

**NOTICE:** Used without the safety alert symbol indicates a potentially hazardous situation which, if not avoided, **may** result in **property damage**.

IF YOU HAVE ANY QUESTIONS OR COMMENTS ABOUT THIS OR ANY DEWALT TOOL, CALL US AT: **1800 654 155** (Aust) or **0800 339258** (NZ).

### SAFETY INSTRUCTIONS FOR POWER TOOLS

When using power tools, always observe the safety regulations applicable in your country to reduce the risk of fire, electric shock and personal injury. Read the following safety instructions before attempting to operate this product. Keep these instructions in a safe place.



**WARNING:** To reduce the risk of injury, read the instruction manual.

### GENERAL POWER TOOL SAFETY WARNINGS



**WARNING! Read all safety warnings and all instructions** Failure to follow the warnings and instructions may result in electric shock, fire and/or serious injury.

The term "power tool" in the warnings refers to your mains-operated (corded) power tool or battery-operated (cordless) power tool.

## SAVE THESE INSTRUCTIONS

### 1) WORK AREA SAFETY

- a) **Keep work area clean and well lit.** Cluttered or dark areas invite accidents.
- b) **Do not operate power tools in explosive atmospheres, such as in the presence of flammable liquids, gases or dust.** Power tools create sparks which may ignite the dust or fumes.
- c) **Keep children and bystanders away while operating a power tool.** Distractions can cause you to lose control.

### 2) ELECTRICAL SAFETY

- a) **Power tool plugs must match the outlet. Never modify the plug in any way. Do not use any adapter plugs with earthed (grounded) power tools.** Unmodified plugs and matching outlets will reduce risk of electric shock.
- b) **Avoid body contact with earthed or grounded surfaces such as pipes, radiators, ranges and refrigerators.** There is an increased risk of electric shock if your body is earthed or grounded.
- c) **Do not expose power tools to rain or wet conditions.** Water entering a power tool will increase the risk of electric shock.
- d) **Do not abuse the cord. Never use the cord for carrying, pulling or unplugging the power tool. Keep cord away from heat, oil, sharp edges or moving parts.** Damaged or entangled cords increase the risk of electric shock.
- e) **When operating a power tool outdoors, use an extension cord suitable for outdoor use.** Use of a cord suitable for outdoor use reduces the risk of electric shock.

### 3) PERSONAL SAFETY

- a) **Stay alert, watch what you are doing and use common sense when operating a power tool. Do not use a power tool while you are tired or under the influence of drugs, alcohol or medication.** A moment of inattention while operating power tools may result in serious personal injury.
- b) **Use safety equipment. Always wear eye protection.** Protective equipment such as dust mask, non-skid safety shoes, hard hat, or hearing protection used for appropriate conditions will reduce personal injuries.

- c) **Prevent unintentional starting. Ensure the switch is in the off position before plugging in.** Carrying power tools with your finger on the switch or plugging in power tools that have the switch on invites accidents.
- d) **Remove any adjusting key or wrench before turning the power tool on.** A wrench or a key left attached to a rotating part of the power tool may result in personal injury.
- e) **Do not overreach. Keep proper footing and balance at all times.** This enables better control of the power tool in unexpected situations.
- f) **Dress properly. Do not wear loose clothing or jewellery. Keep your hair, clothing and gloves away from moving parts.** Loose clothes, jewellery or long hair can be caught in moving parts.
- g) **If devices are provided for the connection of dust extraction and collection facilities, ensure these are connected and properly used.** Use of dust collection can reduce dust-related hazards.

#### 4) POWER TOOL USE AND CARE

- a) **Do not force the power tool. Use the correct power tool for your application.** The correct power tool will do the job better and safer at the rate for which it was designed.
- b) **Do not use the power tool if the switch does not turn it on and off.** Any power tool that cannot be controlled with the switch is dangerous and must be repaired.
- c) **Disconnect the plug from the power source and/or the battery pack from the power tool before making any adjustments, changing accessories, or storing power tools.** Such preventive safety measures reduce the risk of starting the power tool accidentally.
- d) **Store idle power tools out of the reach of children and do not allow persons unfamiliar with the power tool or these instructions to operate the power tool.** Power tools are dangerous in the hands of untrained users.
- e) **Maintain power tools. Check for misalignment or binding of moving parts, breakage of parts and any other condition that may affect the power tool's operation. If damaged, have the power tool repaired before use.** Many accidents are caused by poorly maintained power tools.

- f) **Keep cutting tools sharp and clean.** Properly maintained cutting tools with sharp cutting edges are less likely to bind and are easier to control.
- g) **Use the power tool, accessories and tool bits etc., in accordance with these instructions and in the manner intended for the particular type of power tool, taking into account the working conditions and the work to be performed.** Use of the power tool for operations different from those intended could result in a hazardous situation.

#### 5) SERVICE

- a) **Have your power tool serviced by a qualified repair person using only identical replacement parts.** This will ensure that the safety of the power tool is maintained.

#### *Electrical Safety*

The electric motor has been designed for one voltage only. Always check that the power supply corresponds to the voltage on the rating plate. 230 V AC means your tool will operate on alternating current. As little as 10% lower voltage can cause loss of power and can result in overheating. All DeWALT tools are factory tested; if this tool does not operate, check the power supply. Your DeWALT tool is double insulated, therefore no earth wire is required.

- **Young children and the infirm.** This appliance is not intended for use by young children or infirm persons without supervision. Young children should be supervised to ensure that they do not play with this appliance.
- **Replacement of the supply cord.** If the supply cord is damaged, it must be replaced by the manufacturer or an authorised DeWALT Service Centre in order to avoid a hazard.

#### *Extension Cords*

**⚠ CAUTION:** Use only extension cords that are approved by the country's Electrical Authority. Before using extension cords, inspect them for loose or exposed wires, damaged insulation and defective fittings. Replace the cord if necessary.

MINIMUM GAUGE FOR CORD SETS						
For Cable length (m):	7.5	15	25	30	45	60
Use Cable with minimum rating (Amperes)						
Tool Amperes						
0 - 3.4	7.5	7.5	7.5	7.5	7.5	7.5
3.5 - 5.0	7.5	7.5	7.5	7.5	10	15
5.1 - 7.0	10	10	10	10	15	15
7.1 - 12.0	15	15	15	15	20	20
12.1 - 20.0	20	20	20	20	25	–

### Additional Safety Instructions for Rotary Hammers

- **Wear ear protectors.** Exposure to noise can cause hearing loss.
- **Use auxiliary handle(s) supplied with the tool.** Loss of control can cause personal injury.
- **Hold power tools by insulated gripping surfaces when performing an operation where the cutting tool may contact hidden wiring or its own cord.** Contact with a “live” wire will make exposed metal parts of the tool “live” and shock the operator.
- **Use clamps or other practical way to secure and support the workpiece to a stable platform.** Holding the work by hand or against your body is unstable and may lead to loss of control.
- **Wear safety goggles or other eye protection.** Hammering operations cause chips to fly. Flying particles can cause permanent eye damage. Wear a dust mask or respirator for applications that generate dust. Ear protection may be required for most applications.
- **Keep a firm grip on the tool at all times. Do not attempt to operate this tool without holding it with both hands.** It is recommended that the side handle be used at all times. Operating this tool with one hand will result in loss of control. Breaking through or encountering hard materials such as re-bar may be hazardous as well. Tighten the side handle securely before use.
- **Do not operate this tool for long periods of time.** Vibration caused by hammer action may be harmful to your hands and arms. Use gloves to provide extra cushion and limit exposure by taking frequent rest periods.
- **Do not recondition bits yourself.** Chisel reconditioning should be done by an authorized specialist. Improperly reconditioned chisels could cause injury.

- **Wear gloves when operating tool or changing bits.** Accessible metal parts on the tool and bits may get extremely hot during operation. Small bits of broken material may damage bare hands.
- **Never lay the tool down until the bit has come to a complete stop.** Moving bits could cause injury.
- **Do not strike jammed bits with a hammer to dislodge them.** Fragments of metal or material chips could dislodge and cause injury.
- **Slightly worn chisels can be resharpened by grinding.**  
**NOTE:** Do not overheat the bit (discoloration) while grinding a new edge. Badly worn chisels require reforging. Do not reharden and temper the chisel.
- **Keep the power cord away from the rotating bit. Do not wrap the cord around any part of your body.** An electric cord wrapped around a spinning bit may cause personal injury and loss of control.
- **Air vents often cover moving parts and should be avoided.** Loose clothes, jewellery or long hair can be caught in moving parts.

**⚠ WARNING: ALWAYS wear approved protective safety equipment complying with the following standards:**

- Eye protection: AS/NZS1337 Eye Protectors for Industrial Applications;
- Hearing protection: AS/NZS1270 Acoustics – Hearing Protection;
- Respiratory protection: AS/NZS1716 Respiratory Protective Devices.

**⚠ WARNING:** Some dust created by power sanding, sawing, grinding, drilling, and other construction activities contains chemicals known to cause cancer, birth defects or other reproductive harm. Some examples of these chemicals are:

- lead from lead-based paints,
- crystalline silica from bricks and cement and other masonry products, and
- arsenic and chromium from chemically-treated lumber (CCA).

Your risk from these exposures varies, depending on how often you do this type of work. To reduce your exposure to these chemicals: work in a well ventilated area, and work with approved safety equipment, such as those dust masks that are specially designed to filter out microscopic particles.

- **Avoid prolonged contact with dust from power sanding, sawing, grinding, drilling, and other construction activities. Wear protective clothing and wash exposed areas with soap and water.** Allowing dust to get into your mouth, eyes, or lay on the skin may promote absorption of harmful chemicals.

**⚠ WARNING:** Use of this tool can generate and/or disburse dust, which may cause serious and permanent respiratory or other injury. Always use AS/NZS standard approved respiratory protection appropriate for the dust exposure. Direct particles away from face and body.

**⚠ WARNING: ALWAYS use eye protection.** All users and bystanders must wear eye protection that conforms to AS/NZS1337.

**⚠ WARNING: ALWAYS wear proper personal hearing protection that conforms to AS/NZS1270 during use.** Under some conditions and duration of use, noise from this product may contribute to hearing loss.

**⚠ WARNING:** We recommend the use of a residual current device with a residual current rating of 30mA or less.

- The label on your tool may include the following symbols. The symbols and their definitions are as follows:

V .....	volts	A .....	amperes
Hz .....	hertz	W .....	watts
min .....	minutes	~ .....	alternating current
— — —  .....	direct current	⎓ .....	alternating or direct current
⏚ .....	Class I Construction (grounded)	no .....	no load speed
□ .....	Class II Construction (double insulated)	⊕ .....	earthing terminal
.../min .....	per minute	⚠ .....	safety alert symbol
		BPM .....	beats per minute
		RPM .....	revolutions per minute

### Markings on Tool

The following pictograms are shown on the tool:



Read instruction manual before use.



Wear ear protection.



Wear eye protection.

FIG. 1

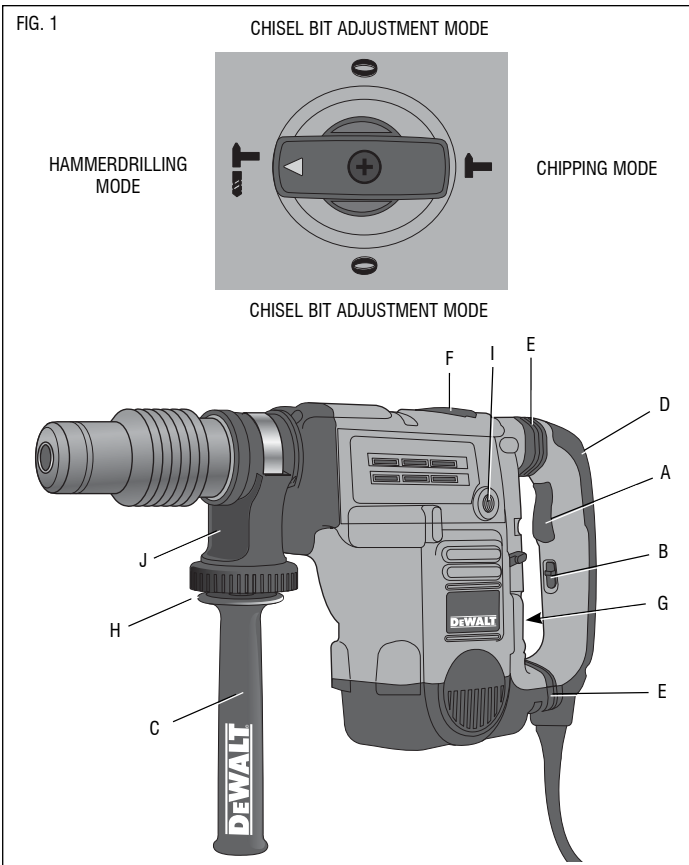

## **SAVE THESE INSTRUCTIONS FOR FUTURE USE**

### **Motor**

Your DEWALT tool is powered by a DEWALT-built motor. Be sure your power supply agrees with the nameplate markings. Voltage decrease of more than 10% will cause loss of power and overheating. All DEWALT tools are factory tested.

### **COMPONENTS (Fig. 1, 2)**

**▲ WARNING:** Never modify the power tool or any part of it. Damage or personal injury could result.

- |   |                     |
|---|---------------------|
| A. Trigger switch                           | L. Bush             |
| B. Lock-on slider                           | M. Tool holder      |
| C. Side handle                              | N. Pin              |
| D. Main handle                              | O. Collar           |
| E. Active vibration control                 | P. Locking sleeve   |
| F. Mode selector switch                     | Q. Side handle knob |
| G. Electronic speed and impact control dial |                     |
| H. Clamp wheel                              |                     |
| I. Rear side handle position                |                     |
| J. Side handle clamp                        |                     |
| K. Steel ring                               |                     |

### **INTENDED USE**

Your rotary hammer has been designed for professional rotary drilling and chipping applications. **DO NOT** use under wet conditions or in presence of flammable liquids or gasses.

This heavy-duty rotary hammer is a professional power tool. **DO NOT** let children come into contact with the tool. Supervision is required when inexperienced operators use this tool.

### **Soft Start Feature**

The soft start feature allows the speed to build up slowly, thus preventing the drill bit from walking off the intended hole position when starting.

The soft start feature also reduces the immediate torque reaction transmitted to the gearing and the operator if the hammer is started with the drill bit in an existing hole.

### **Electronic Speed and Impact Control (Fig. 1, 3)**

The electronic speed and impact control (G) offers the following advantages:

- use of smaller accessories without risk of breakage;
- minimised break-out when chiselling or drilling in soft or brittle materials;
- optimal tool control for precise chiselling.

### **Torque Limiting Clutch**

The torque limiting clutch reduces the maximum torque reaction transmitted to the operator in case of jamming of a drill bit. This feature also prevents the gearing and electric motor from stalling. The torque limiting clutch has been factory-set and cannot be adjusted.

### **Complete Torque Control (Fig. 3)**

**NOTICE:** Always turn the tool off before changing torque control settings or damage to tool may result.

The Complete Torque Control (CTC) feature of this tool is designed to provide additional control with a two-stage clutch mechanism. Refer to **Setting the Torque Control Switch** for more information.

### **Service Indicator LEDs (Fig. 3)**

The yellow brushwear indicator LED (S) lights up when the carbon brushes are nearly worn out to indicate that the tool needs servicing within the next 8 hours of use.

The red service indicator LED (T) lights up if the lock-on button (B) is used in any mode except the chipping mode. In all models with the adaptive drill control (ADC), the red indicator LED (T) lights up if the ADC is engaged. The red indicator starts to flash if there is a fault with the tool or the brushes have completely worn out (refer to **Brushes** under **Maintenance**).

### **Fully Vibration-dampened Main Handle (Fig. 1)**

The dampers in the side handle (C) absorb the vibrations transmitted to the user. This improves user comfort during the operation.

### Side Handle (Fig. 1)

**⚠ WARNING:** To reduce the risk of personal injury, **ALWAYS** operate the tool with the side handle properly installed and securely tightened. Failure to do so may result in the side handle slipping during tool operation and subsequent loss of control. Hold tool with both hands to maximize control.

The side handle (c) can be mounted in front or in rear position on either side of the machine to suit both RH- and LH-users.

**⚠ WARNING:** Always operate the tool with the side handle properly assembled.

FIG. 2A

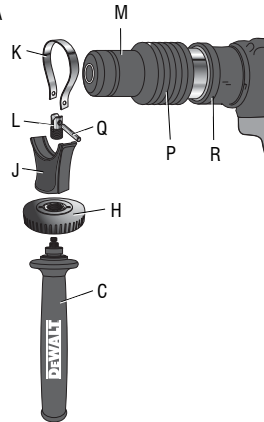

#### MOUNTING IN FRONT POSITION (FIG. 2A)

1. Snap the steel ring (K) over the collar (R) behind the tool holder (M). Squeeze both ends together, mount the bush (L) and insert the pin (Q).
2. Place the side handle clamp (J) and screw on the clamp wheel (H). Do not tighten.

FIG. 2B

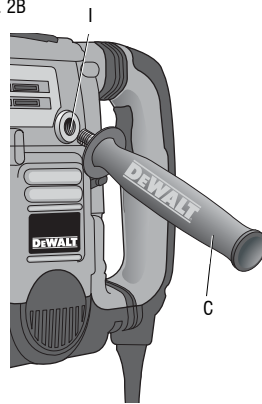

**⚠ WARNING:** Once assembled, the side handle clamp should never be removed.

3. Screw the side handle (C) into the bush (L) and then into clamp wheel. Tighten securely.
4. Rotate the side handle mounting assembly to the desired position. For drilling horizontally with a heavy drill bit, we recommend to place the side handle at an angle of approx. 20° for optimum control.
5. Lock the side handle mounting assembly in place by tightening the clamp wheel (H).

#### MOUNTING IN REAR POSITION (FIG. 2B)

The rear position is particularly useful when drilling down into a floor.

1. Unscrew the side handle (C) and remove it from the front position. Leave the side handle mounting assembly in front position.
2. Screw the side handle directly into one of the rear side handle positions (I) on either side of the tool.

#### Selecting the Operating Mode (Fig. 1)



##### Hammerdrilling:

for concrete, brick, stone and masonry drilling operations.

##### Hammering only:

for chiselling and demolition applications. In this mode the tool can also be used as a lever to free a jammed drill bit.

1. To select the operating mode, rotate the mode selector switch (F) until it points to the symbol of the required mode.  
It may be necessary to twist the tool holder (M) slightly to allow the mode selector switch (F) to pass the O position.
2. Check that the mode selector switch (F) is locked in place.

#### Inserting and Removing SDS Max® Accessories (Fig. 1, 4A, 4B)

This machine uses SDS Max® bits and chisels (refer to the inset in figure 4B for a cross-section of an SDS Max® bit shank).

1. Clean the bit shank.
2. Pull back the locking sleeve (P) and insert the bit shank.
3. Turn the bit slightly until the sleeve snaps into position.

4. Pull on the bit to check if it is properly locked. The hammering function requires the bit to be able to move axially several centimetres when locked in the tool holder.
5. To remove a bit pull back the tool holder locking sleeve/collar and pull the bit out of the tool holder.

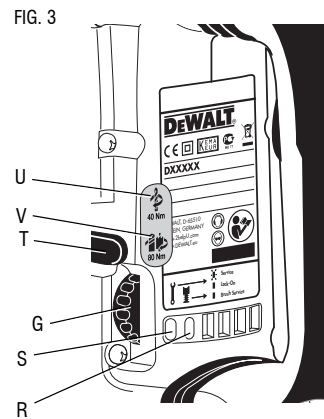

### Setting the Electronic Speed and Impact Control Dial (Fig. 1, 3)

Turn the dial (G) to the desired level. Turn the dial upwards for higher speed and downwards for lower speed. The required setting is a matter of experience. E.g.:

- when chiselling or drilling in soft, brittle materials or when minimum break-out is required, set the dial to a low setting;
- when breaking or drilling in harder materials, set the dial to a high setting.

### Setting the Torque Control Switch (Fig. 3)

**NOTICE:** Always turn the tool off before changing torque control settings or damage to the tool may result.

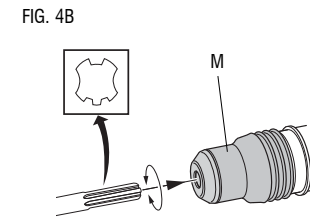
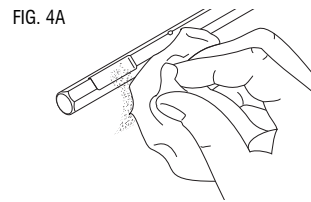

Move the torque control lever (T) to setting 40 Nm or 80 Nm as needed for application.

Clutch Setting 40 Nm (U) is designed for most drilling applications and is designed to easily clutch out when the drill bit encounters re-bar or other foreign substances.

Clutch Setting 80 Nm (V) is designed for higher torque applications such as core-bits and deep hole drilling and is designed to clutch out at a higher torque threshold.

**NOTE:** Allow the motor housing to rotate a little while changing torque.

Each time the tool is plugged in, it will automatically default to clutch setting 1 into clutch setting 40 Nm (U), the most sensitive setting.

### Indexing the Chisel Position (Fig. 5)

The chisel can be indexed and locked into 18 different positions.

1. Rotate the mode selector switch (F) until it points towards the  position.
2. Rotate the chisel in the desired position.
3. Set the mode selector switch (F) to the "hammering only" position.
4. Twist the chisel until it locks in position.

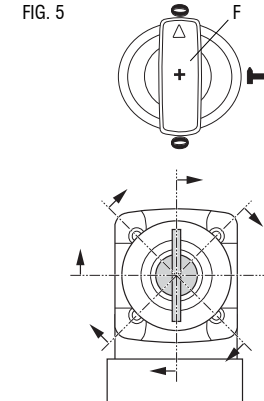

### OPERATION

**⚠ WARNING:** To reduce the risk of serious personal injury, turn tool off and disconnect tool from power source before making any adjustments or removing/installing attachments or accessories.

**⚠ WARNING:** To reduce the risk of personal injury, ALWAYS ensure workpiece is anchored or clamped firmly. If drilling thin material, use a wood "back-up" block to prevent damage to the material.

**⚠ WARNING:** To reduce the risk of personal injury, ALWAYS operate the tool with the side handle properly installed and securely tightened. Failure to do so may result in the side handle slipping during tool operation and subsequent loss of control.



**⚠ WARNING:** The use of a residual current device (RCD) protected supply with a rated residual current of 30 mA or less is recommended. The use of a RCD reduces the risk of electric shock.

Hold tool with both hands to maximize control.

### **Trigger Switch (Fig. 1)**

To turn the tool on, depress the trigger switch (A).

To stop the tool, release the trigger switch.

The lock-on slider (B) allows the trigger switch (A) to be locked on in chiselling mode only. If the lock-on button is activated in drilling mode, as a feature the tool will switch off automatically.

To turn the tool on, press the trigger switch (A).

To stop the tool, release the switch.

For continuous operation, press and hold down the switch (A), slide the lock-on button (B) upwards and release the switch.

To stop the tool in continuous operation, press the switch briefly and release it. Always switch off the tool when work is finished and before unplugging.

### **Proper Hand Position (Fig. 6)**

**⚠ WARNING:** To reduce the risk of serious personal injury, **ALWAYS** use proper hand position as shown.

**⚠ WARNING:** To reduce the risk of serious personal injury, **ALWAYS** hold securely in anticipation of a sudden reaction.

Proper hand position requires one hand on the side handle (C), with the other hand on the main handle (D).

### **Hammerdrilling**

To turn the tool on, press the on/off switch (A).

To stop the tool, release the switch.

FIG. 6

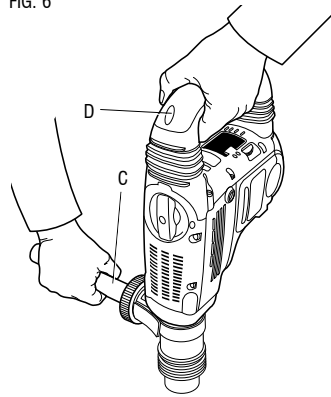

### **Drilling with a Solid Bit (Fig. 1)**

1. Insert the appropriate drill bit.
2. Set the mode selector switch (F) to the hammerdrilling position.
3. Set the electronic speed and impact control dial (G).
4. Fit and adjust the side handle (C).
5. Mark the spot where the hole is to be drilled.
6. Place the drill bit on the spot and switch on the tool.
7. Always switch off the tool when work is finished and before unplugging.

### **Drilling with a Core Bit (Fig. 1)**

1. Insert the appropriate core bit.
2. Assemble the centerdrill into the core bit.
3. Set the mode selector switch (F) to the hammerdrilling position.
4. Turn the electronic speed and impact control dial (G) to a medium or high speed setting.
5. Fit and adjust the side handle (C).
6. Place the centerdrill on the spot and switch on the tool. Drill until the core penetrates into the concrete approx. 1 cm.
7. Stop the tool and remove the centerdrill. Place the core bit back into the hole and continue drilling.
8. When drilling through a structure thicker than the depth of the core bit, break away the round cylinder of concrete or core inside the bit at regular intervals.  
To avoid unwanted breaking away of concrete around the hole, first drill a hole the diameter of the centerdrill completely through the structure. Then drill the cored hole halfway from each side.
9. Always turn the tool off when work is finished and before unplugging.

### **Chipping and Chiselling (Fig. 1)**

1. Insert the appropriate chisel and rotate it by hand to lock it into one of 18 positions.
2. Set the mode selector switch (F) to the hammering only position.
3. Set the electronic speed and impact control dial (G).

4. Fit and adjust the side handle (C).
5. Turn the tool on and start working.
6. Always turn the tool off when work is finished and before unplugging.

## MAINTENANCE

**⚠ WARNING: Shock Hazard. To reduce the risk of serious personal injury, turn tool off and disconnect from power source before making any adjustments or removing/installing attachments or accessories.**

### *Brushes (Fig. 3)*

The carbon brushes are not user-serviceable. Take the tool to an authorized DEWALT repair agent.

The yellow brushwear indicator LED (R) lights up when the carbon brushes are nearly worn out. After a further 8 hours of use or after the brushes have completely worn out the motor will automatically be shut off.

Tool maintenance needs to be carried out as soon as the service indicator (S) lights up.

### *Lubrication*

Your power tool requires no additional lubrication.

### *Cleaning*

**⚠ WARNING:** Blow dirt and dust out of all air vents with clean, dry air at least once a week. To minimize the risk of eye injury, always wear AS/NZS standard approved eye protection when performing this.

**⚠ WARNING:** Never use solvents or other harsh chemicals for cleaning the non-metallic parts of the tool. These chemicals may weaken the plastic materials used in these parts. Use a cloth dampened only with water and mild soap. Never let any liquid get inside the tool; never immerse any part of the tool into a liquid.

### *Repairs*

To assure product SAFETY and RELIABILITY, repairs, maintenance and adjustment (including brush inspection and replacement) should be performed by certified service centers or other qualified service organizations, always using identical replacement parts.

## ACCESSORIES

**⚠ WARNING:** Since accessories, other than those offered by DEWALT, have not been tested with this product, use of such accessories with this tool could be hazardous. To reduce the risk of injury, only DEWALT, recommended accessories should be used with this product.

Recommended accessories for use with your tool are available at extra cost from your local service center. If you need any assistance in locating any accessory, please contact DEWALT Industrial Tool Co., 20 Fletcher Road, Mooroolbark, VIC 3138 Australia or call 1800 654 155 or (NZ) 0800 339258.

MAXIMUM CAPACITY	
D25712-XE	
Concrete	48 mm (1-7/8")
RPM	137–275
No load BPM	1260–2520

### *Guarantee*

Applicable to hand held Power Tools, Lasers and Nailers.

### *Three Year Limited Warranty*

DEWALT will repair, without charge, any defects due to faulty materials or workmanship for three years from the date of purchase. Please return the complete unit, transportation prepaid, to any DEWALT Service Centre, or any authorised service station.

For warranty repair information, call (AUS) 1800 654 155 or (NZ) 0800 339258.

This warranty does not apply to

- Accessories
- Damage caused where repairs have been made or attempted by others.
- Damage due to misuse, neglect, wear and tear, alteration or modification.

This warranty gives you specific legal rights and you may have other rights under the provisions of the Consumer Guarantee Act 1993 (New Zealand only), Trade Practices Act 1974 and State Legislation (Australia only).

In addition to the warranty, DeWALT tools are covered by our:

**FREE ONE YEAR SERVICE CONTRACT**

DeWALT will also maintain the tool for free at any time during the first year of purchase. This includes labour, parts and lubrication required to restore the product to sound mechanical and/or electrical condition. Normal wear parts are not covered in this service. Carbon brushes worn more than 50% will be replaced.

**NOTE:** Three Year Warranty is not applicable to items deemed as consumables. Radial arm saws are covered by a one (1) year warranty only. DeWALT Reserves the right to review its warranty policy prior to launch of any new business development products.

**30 DAY NO SATISFACTION GUARANTEE**

If you are dissatisfied with any DeWALT power tool, laser or nailer, for any reason, simply return it to the point of purchase with your sales receipt within 30 days for a replacement unit or a full refund.

**FREE WARNING LABEL REPLACEMENT:** If your warning labels become illegible or are missing, call (AUS) 1800 654 155 or (NZ) 0800 339258 for a free replacement.



DEWALT Industrial Tool Co.,  
701 East Joppa Road, Baltimore, MD 21286 • 20 Fletcher Road, Mooroolbark, VIC 3138 Australia  
(JUN10) Part No. N081422 D25711-XE Copyright © 2010 DEWALT

The following are trademarks for one or more DEWALT power tools: the yellow and black color scheme; the “D” shaped air intake grill; the array of pyramids on the handgrip; the kit box configuration; and the array of lozenge-shaped humps on the surface of the tool.